

1 **2**

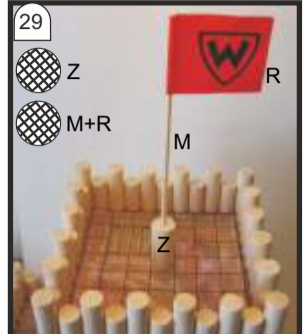
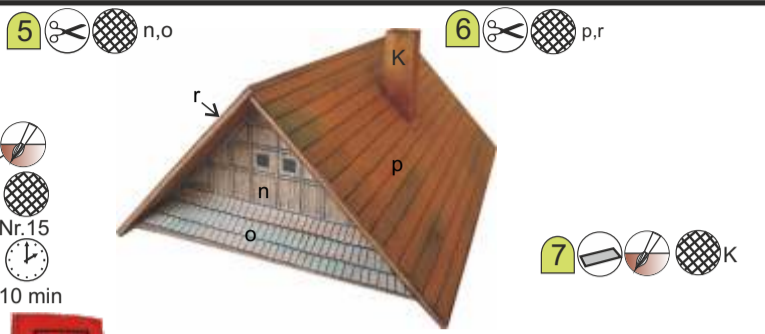
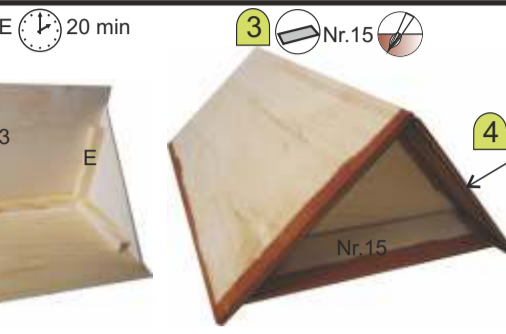
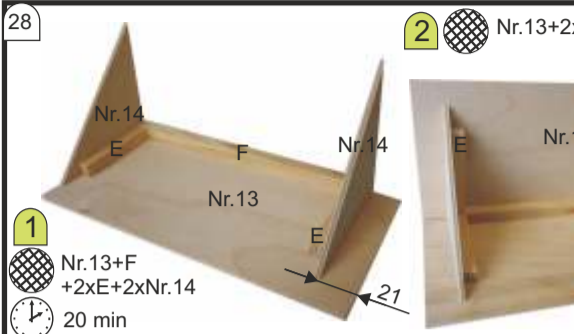
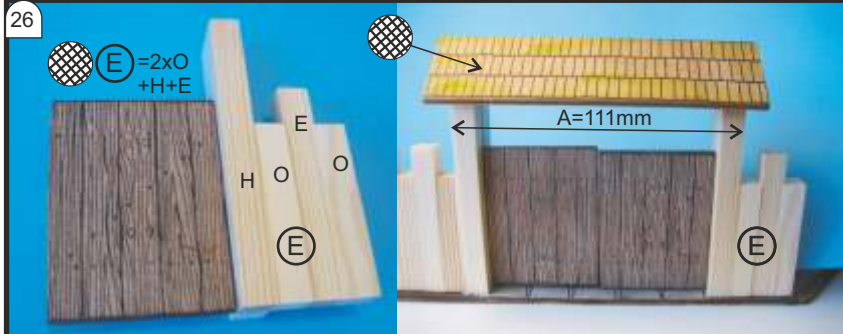
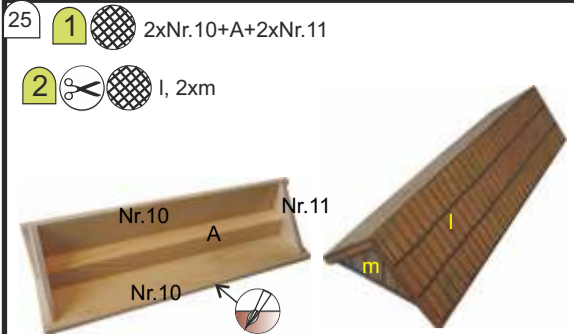

obrousit* sand*abschleifen*sable*zand smerigliare*szlifować*obrusit*csiszolni*отшлифовать zimpáralanacak*obrusiti*lijar

vystřihnout*cut out*ausschneiden*découper uitknippen*ritagliare*wyciąć*vystrihnút*kvágni*вырезать kesilecek*izrezati*recortar

čekat*wait*warten*attendre*wachten*aspettare*czekać*čakat*vámi*ждать*beklenecek*príčekati*tiempo de espera

lepit disperzním lepidlem*dispersion glue*Dispersionklebstoff colle*oplosbare lijm*dispersione adesivo*klej disperzné lepidlo ragasztani*клеить дисперсионным клеем*уяриştirilacak disperzivno ljepilo*expandir pegamento

postup*technique*Montagevor.procedé*montagetechniek fase di montaggio*tehnika*postup*техника монтажа aşama*postupak*seguir orden de montaje

ofiznout*cut*schneiden*couper snijden*tagliare*ciać*orezat*levágni обрезать*kesilecek*odrezati*corjar

hnědá*brown*bräune*brun*bruin*marrone* brazowy*hnědá*barna*коричневый* kahverengi*smeda*marron

water colour Aquarell vodová barva acuarela



ITEMS (En)	Türkçe (TR)	CONTEÚDO(Pt)	(Sp)	INHALT (De)	CONTENU (Fr)	INHOUD (B)	CONTENUTO (I)	TARTALOM (H)	СОДЕРЖАНИЕ (Ru)	(Pl)	OBSAH (Sk)	OBSAH (CZ)	SIZE	NAME	pcs
Castle	Kale	CASTELO	CASTILLO	BURG	CHATEAU	KASTEEL	CASTELLO	VÁR	Зáмок	ZAMEK	Hrad	Hrad	[mm]		
ground plate	Zemin	pavimento	pavimento	Grundplatte	plaque de base	grondplaat	pannello basamento	alaplapp	фундаментная плита	Podstawa	základová doska	základová deska	395x188	Nr.1A	1
ground plate	Zemin	pavimento	pavimento	Grundplatte	plaque de base	grondplaat	pannello basamento	alaplapp	фундаментная плита	Podstawa	základová doska	základová deska	233x162	Nr.1B	1
ground plate	Zemin	pavimento	pavimento	Grundplatte	plaque de base	grondplaat	pannello basamento	alaplapp	фундаментная плита	Podstawa	základová doska	základová deska	162x225/2	Nr.1C	1
battlements terrace		ameias	almenas	Terrasse - Mauerzahn	rempart de terrasse	buitenplaats	terrazza muro di cinta		терраса зубцами	Blanki		terasa cimbuří	140x140	Nr.2	1
battlements terrace		ameias	almenas	Terrasse - Mauerzahn		buitenplaats	terrazza muro di cinta		терраса зубцами	Blanki		terasa cimbuří	192x73	Nr.3	1
battlements terrace		ameias	almenas	Terrasse - Mauerzahn		buitenplaats	terrazza muro di cinta		терраса зубцами	Blanki		terasa cimbuří	122x73	Nr.4	1
tower - floor		Torre - Piso	suelo de la torre	Turm - Boden	sol de tour		pavimento torre		башня - пол	Wieża - podłoga		věž - podlaha	78x78	Nr.5	1
tower - parapet		Torre - Piso	suelo de la torre	Turm - Geländer	parapet de tour		parapetto torre		башня-ограждение	Wieża - parapet		věž - zábradlí	28x81	Nr.6	4
tower - roof	kule-çatı	Torre - Piso	suelo de la torre	Turm - Dachplatte	toit de tour		palda tetto torre		башня - крыша	Wieża - dach		věž - střecha	Z83	Nr.7	4
catwalk - floor		passadiço - piso	PASADIZO PISO	Brücke - Boden	sol de passerelle		pavimento ponte		МОСТ - ПОЛ	Most - podłoga		mostek - podlaha	85x50	Nr.8	1
catwalk - parapet		passadiço - parapeito	PASADIZO PARAPETO	Brücke - Geländer	parapet de passerelle		parapetto ponte		мост - ограждение	Most - balustrada		mostek - zábradlí	85x40	Nr.9	2
gate - roof	kapı-çatı	portão do telhado	porta	Brücke - Geländer	parapet de passerelle	Poort	Tetto portellone		калитка - крыша	Brama - daszek		brána - střecha	123x28	Nr.10	2
gate - gable hardboard	kapı-üçgen çatı	porta	puerta gablete aglomerado	Tor - Giebelplatte	panneau de pignon de porte	Poort	pannelli lat. Portone		калитка - щитами	Brama - daszek		brána - štíty	Z35	Nr.11	2
gate	kapı	portão	puerta	Tor	porte	Poort	portone		калитка - ворота	Brama		brána - vrata	46x61	Nr.12	2
roof hardboard	Çatı	telhado	tejado aglomerado	Dachplatte	panneau de toit	dakplaat	pannello tetto	tető	крыша	Dach	strecha	střecha	103x210	Nr.13	2
gable hardboard	Üçgen Çatı	frontão	gablete aglomerado	Giebelplatte	panneau de pignon	plaat voor de gevels	pannello lucernario	nyereggető	фронтон	Dach	štíť	štíť	Z121	Nr.14	2
roof of gable hardboard	Üçgen Çatı Üstü	beirado	tejado de gablete aglomerado	Giebeldach	panneau de toit de pignon	geveldag	pannello spiovente	nyereggető	крышка фронтона	Dach	stříška štítu	stříška štítu	127x20	Nr.15	1
balk spruce	Kiriş	tábua	obstaculo de madera	Fichtenbalken	pin	balken van sparrenhout	prisma abete	gerenda	брус	Belka	hranol	hranol	9x9x111	A	83
balk spruce	Kiriş	tábua	obstaculo de madera	Fichtenbalken	pin	balken van sparrenhout	prisma abete	gerenda	брус	Belka	hranol	hranol	9x9x71	B	12
balk spruce	Kiriş	tábua	obstaculo de madera	Fichtenbalken	pin	balken van sparrenhout	prisma abete	gerenda	брус	Belka	hranol	hranol	9x9x25	C	66
balk spruce	Kiriş	tábua	obstaculo de madera	Fichtenbalken	pin	balken van sparrenhout	prisma abete	gerenda	брус	Belka	hranol	hranol	9x9x16	D	80
balk spruce	Kiriş	tábua	obstaculo de madera	Fichtenbalken	pin	balken van sparrenhout	prisma abete	gerenda	брус	Belka	hranol	hranol	9x9x62	E	109
balk spruce	Kiriş	tábua	obstaculo de madera	Fichtenbalken	pin	balken van sparrenhout	prisma abete	gerenda	брус	Belka	hranol	hranol	9x9x182	F	32
balk spruce	Kiriş	tábua	obstaculo de madera	Fichtenbalken	pin	balken van sparrenhout	prisma abete	gerenda	брус	Belka	hranol	hranol	9x9x127	G	4
balk spruce	Kiriş	tábua	obstaculo de madera	Fichtenbalken	pin	balken van sparrenhout	prisma abete	gerenda	брус	Belka	hranol	hranol	9x9x87	H	14
balk spruce	Kiriş	tábua	obstaculo de madera	Fichtenbalken	pin	balken van sparrenhout	prisma abete	gerenda	брус	Belka	hranol	hranol	9x9x46,5	I	2
balk spruce	Kiriş	tábua	obstaculo de madera	Fichtenbalken	pin	balken van sparrenhout	prisma abete	gerenda	брус	Belka	hranol	hranol	9x9x41	J	3
balk spruce	Kiriş	tábua	obstaculo de madera	Fichtenbalken	pin	balken van sparrenhout	prisma abete	gerenda	брус	Belka	hranol	hranol	9x9x120	N	8
balk spruce	Kiriş	tábua	obstaculo de madera	Fichtenbalken	pin	balken van sparrenhout	prisma abete	gerenda	брус	Belka	hranol	hranol	9x9x50	O	32
balk spruce	Kiriş	tábua	obstaculo de madera	Fichtenbalken	pin	balken van sparrenhout	prisma abete	gerenda	брус	Belka	hranol	hranol	9x9x150	L	1
balk spruce	Kiriş	tábua	obstaculo de madera	Fichtenbalken	pin	balken van sparrenhout	prisma abete	gerenda	брус	Belka	hranol	hranol	9x9x50	V	4
chimney spruce	Baca	chaminé	chimenea de madera	Kamin	cheminee en pin	schoorsteen	camino	kémény	дымовая труба	Komin	komín	komín	15x15	K	1
cylinder	silindir	cilindro	cilindro	Zylinder	cyindre	Cylinder	cilindro	henger	цилиндр	Cylinder	valec	válec	d15x35	Z	1
cylinder	silindir	cilindro	cilindro	Zylinder		Cylinder	cilindro	henger	цилиндр	Cylinder	valec	válec	d12x37	X	45
cylinder	silindir	cilindro	cilindro	Zylinder		Cylinder	cilindro	henger	цилиндр	Cylinder	valec	válec	d12x25	Y	41
stick	direk	barrote	barrote	Stock	baton	stok	gradini scala	rúd	дерев.шпильки	Patyk	špajdle	špejle	150	M	1
flag	bayrak	bandeira	bandera	Flagge	drapeau	Vlag	bandiera	aranyzab	флаг	Flaga	vlajka	vlajka		R	1
four-pane window cardboard	Pencere çerçevesi	janela	crisales ventanas de carton	Fenster aus Karton	fenêtre à quatre carreaux	venster	finestra cartone	négytáblás ablak	окно (картон)	Okno	okno kartón	okno karton	30x30	W30	12
window foil	Pencere Camı	caixilho	ventana de aluminio	Fensterscheibe	pellicule pour fenetre	folie	pellicola finestre	ablaküveg	оконная пленка	Folia okienna	okenná fólia	okenni folie	80x80	foil	2
door cut-out cardboard	Kapı	porta	puerta de carton recortable	Tür und Türrahmen aus Karton	porte en carton	deur	porta cartone	ajtólapp	дверь (картон)	Drzwi	dvere kartón	dveře karton	36x60	D36	3
door cut-out cardboard	Kapı	porta	puerta de carton recortable	Tür und Türrahmen aus Karton	porte en carton	deur	porta cartone	ajtólapp	дверь (картон)	Drzwi	dvere kartón	dveře karton	43x60	D43	2
ribbon for hinges	Menteşe Şeridi	dobraďičas	cinta para visagras	Band als Türscharniere	ruban pour charnières	lint voor deurscharniere	nastro per cerniere	ajtópánt	лента для петель	Taśma na zawiasy	páska na závěsy	páska na závěsy	5x160	S,textil	1
decal set	Kaplama(Zemin ve Çatı)	autocolantes	autoadhesivos	Bedruckte Vortage mit Grundriß	planche decalcomanie	pagina voorbedrukt decorset	stampati con planimetria	matrica	приложение (наклейки)	Naklejki	příloha nálepký	příloha potisků	A3	a-r	2
abrasive paper	Zımpara Kağıdı	lixa	lija	Schleifpapier	papier abrasif	schuurpapier	carta abrasiva	csiszolópapír	шлифовальная бум.	Papier ścierny	šmirgový papier	brusný papír			2

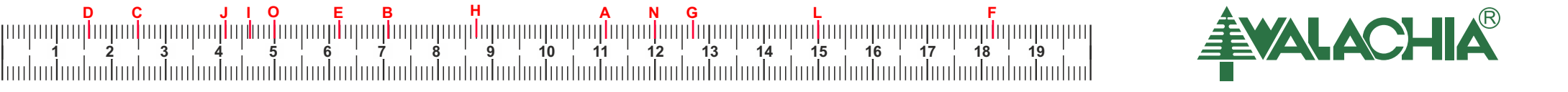

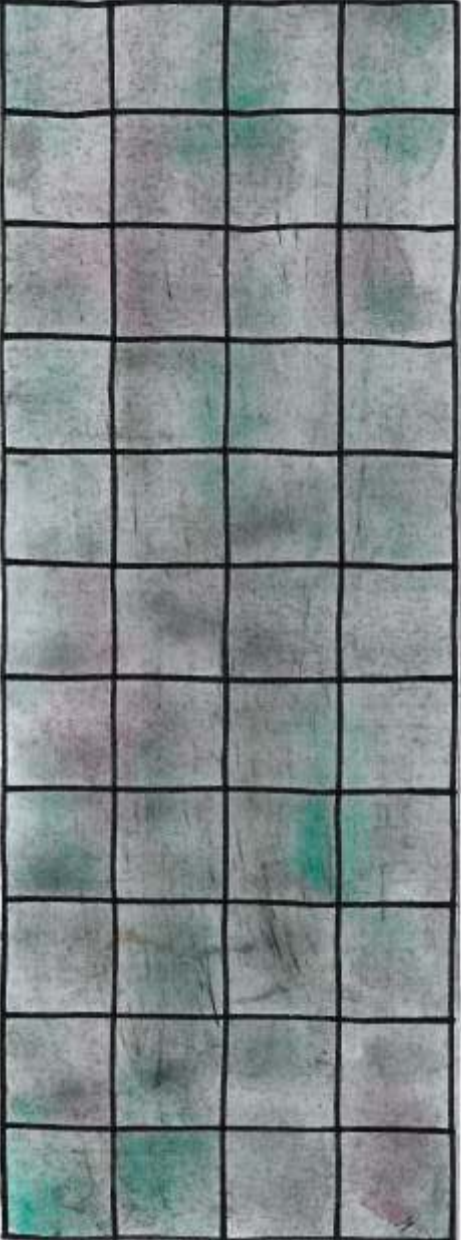

d

r

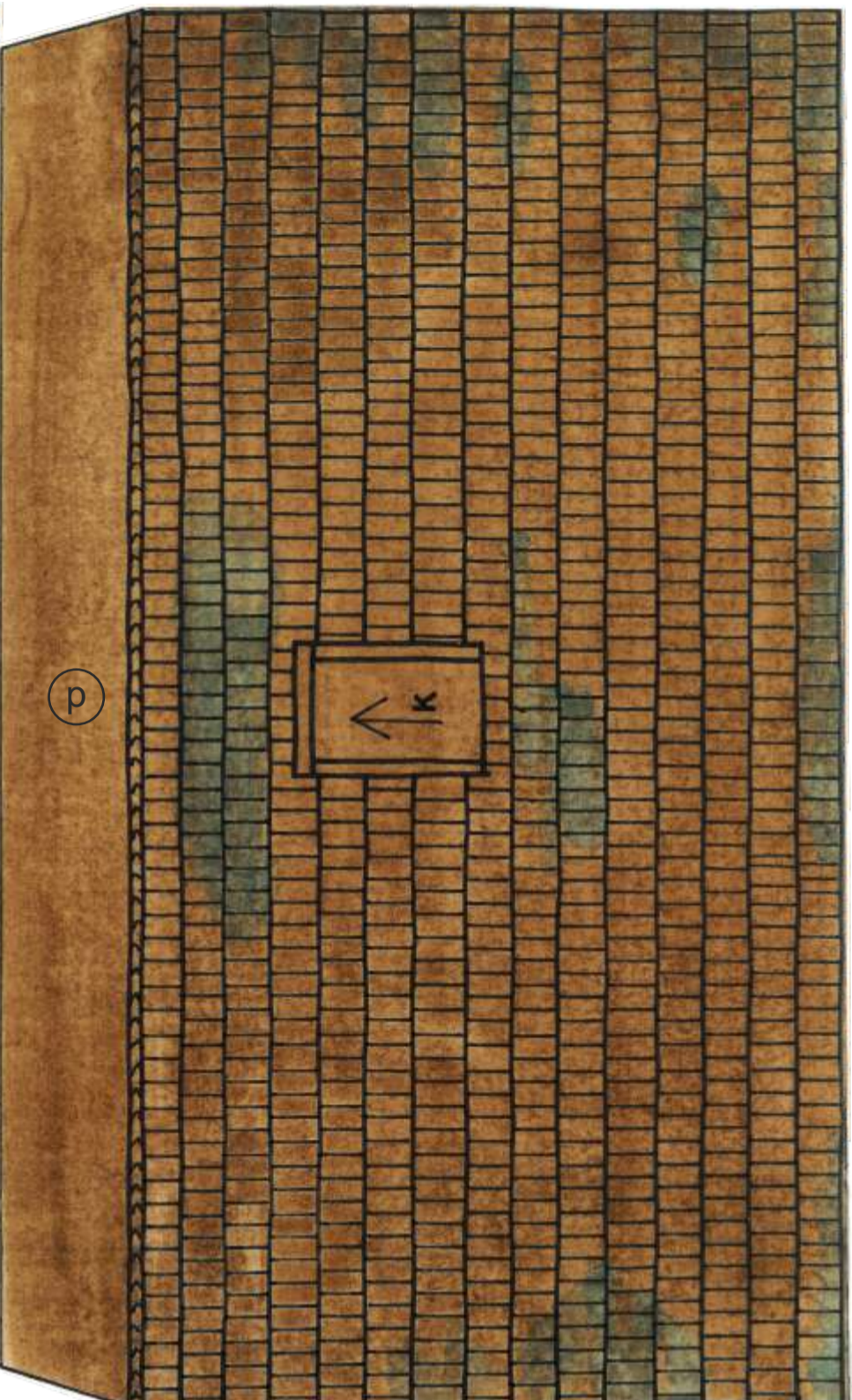
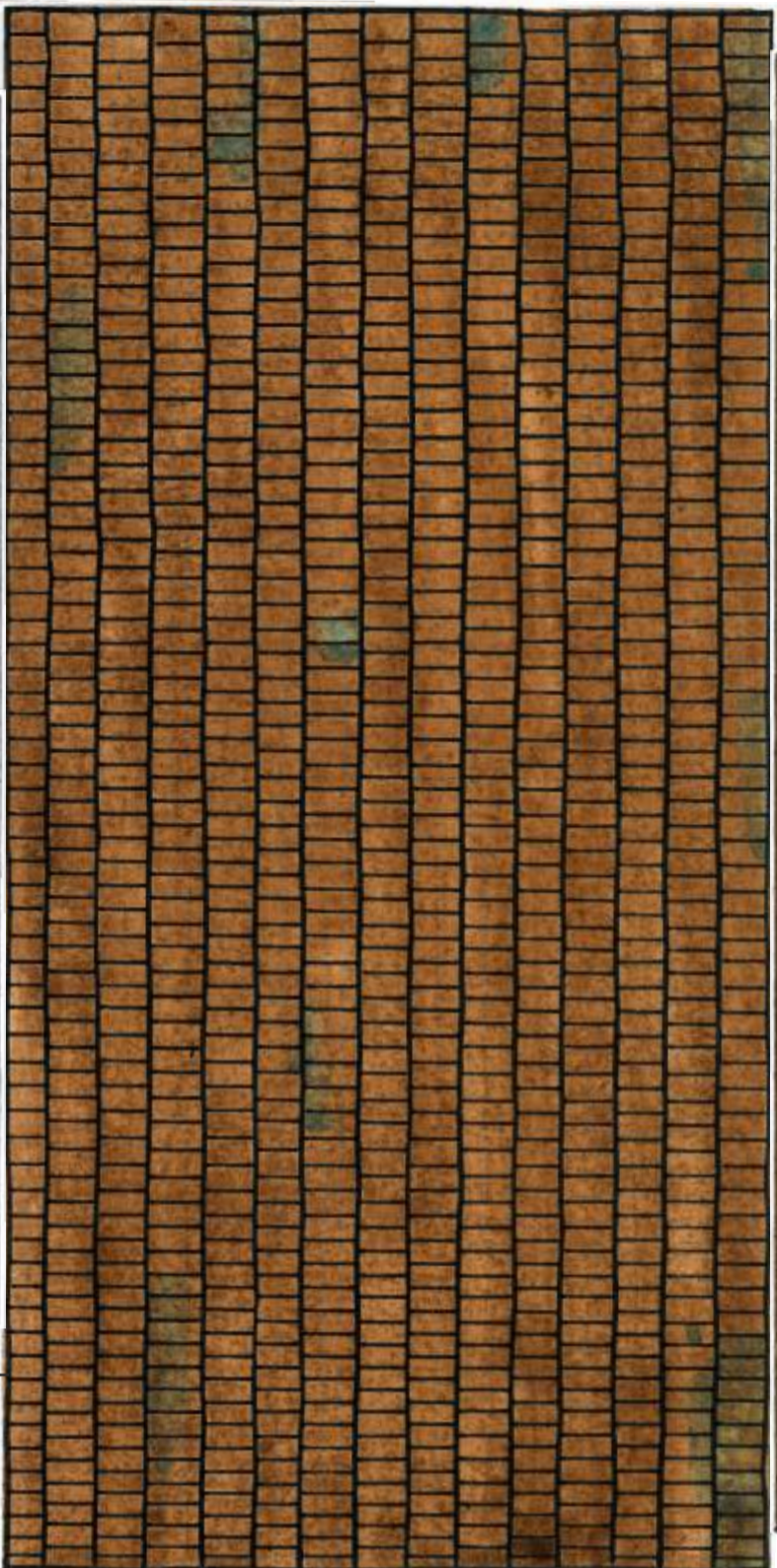

p



h

i



k

j

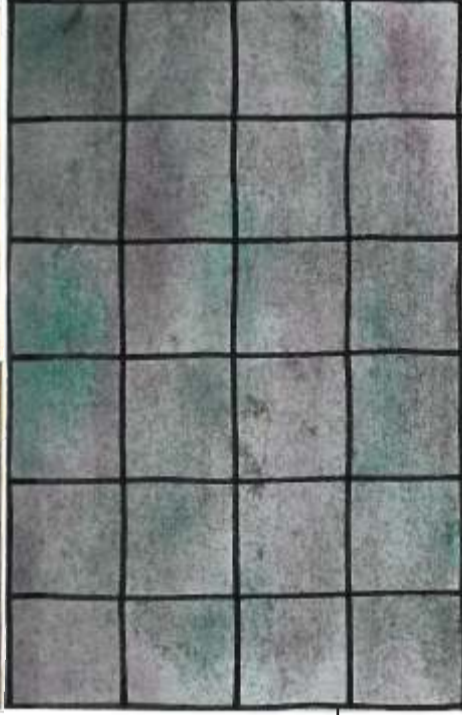

c

b

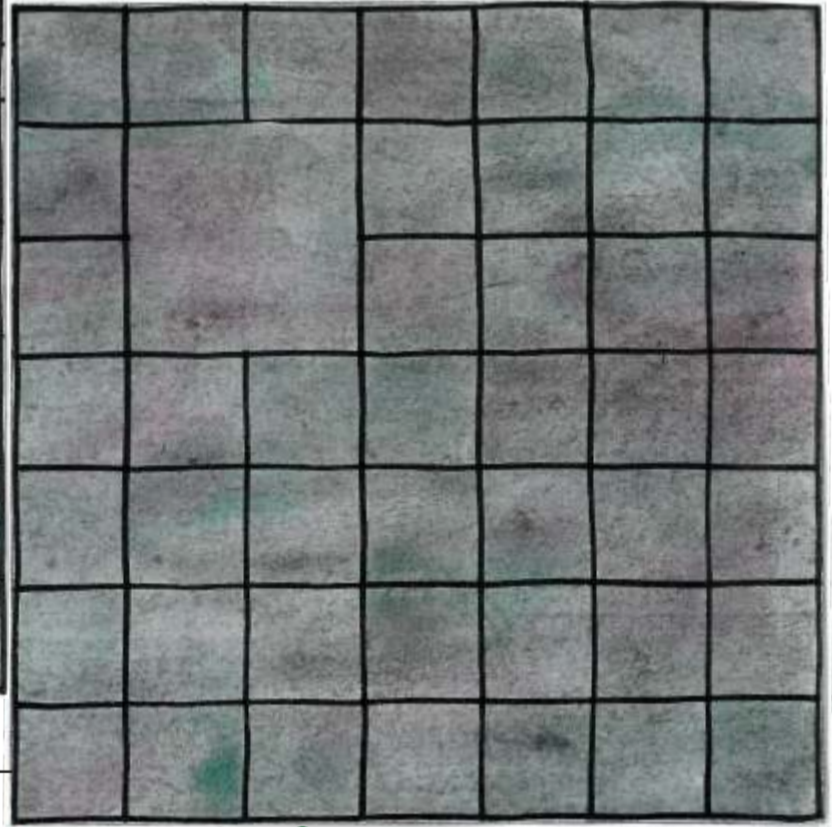

g

WALACHIA®

e

Nr. 19



b1



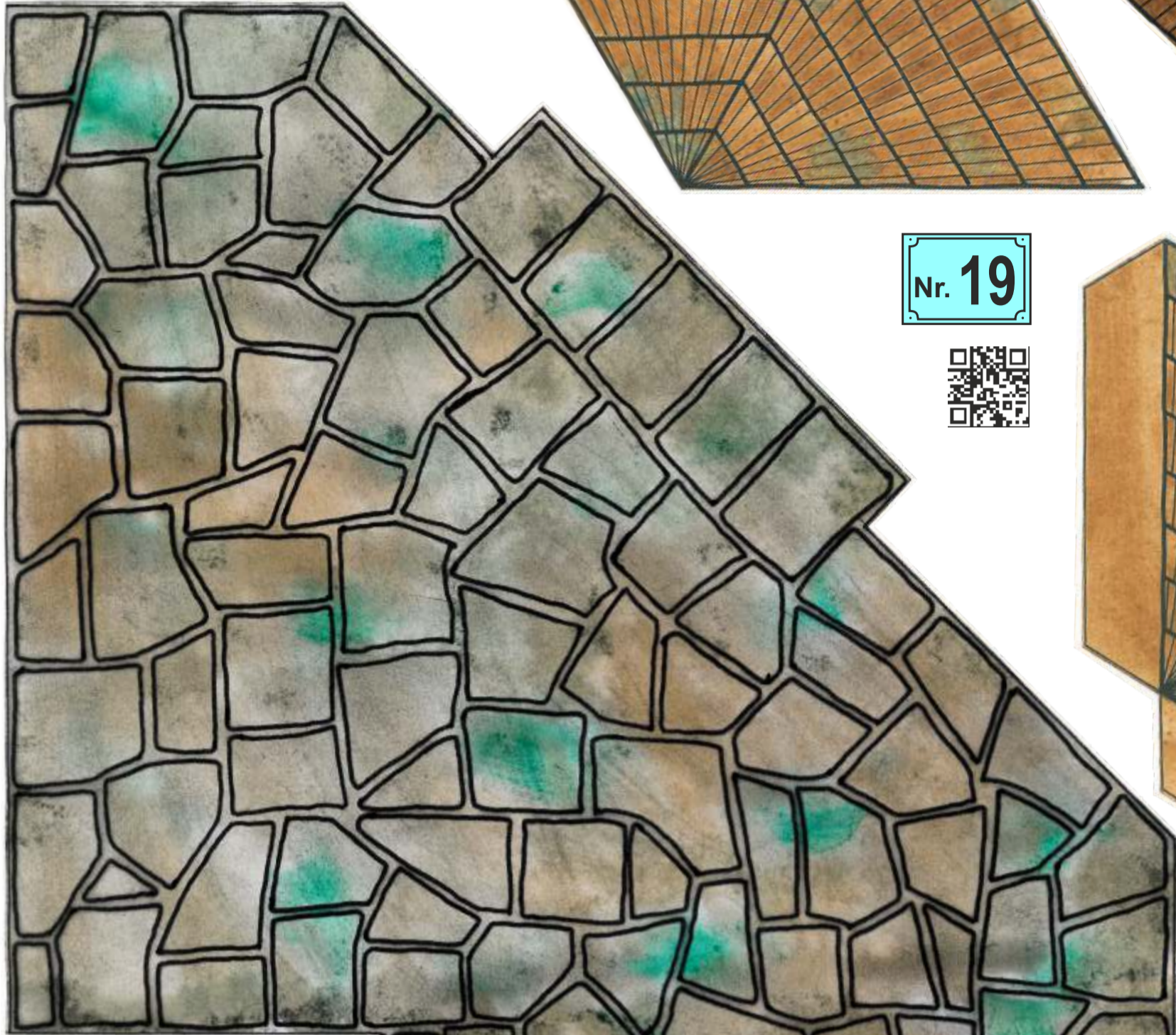
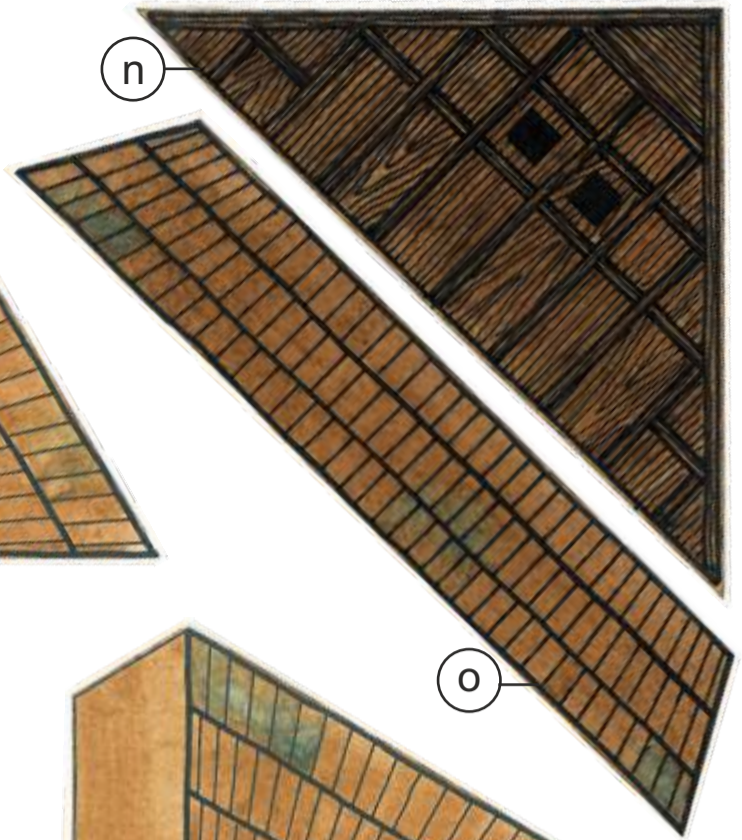
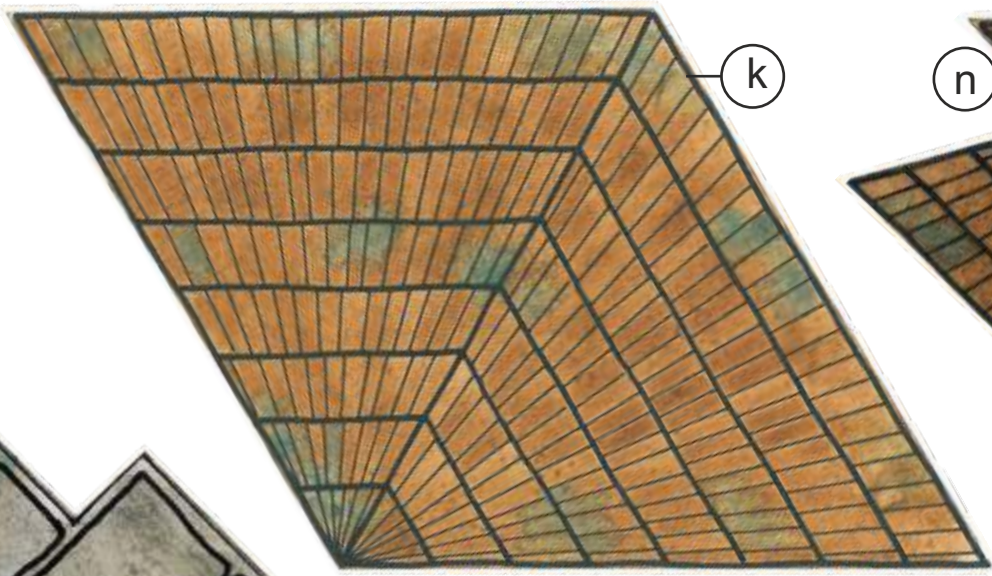

Nr. 19

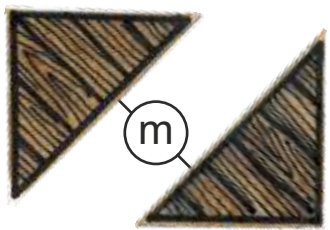
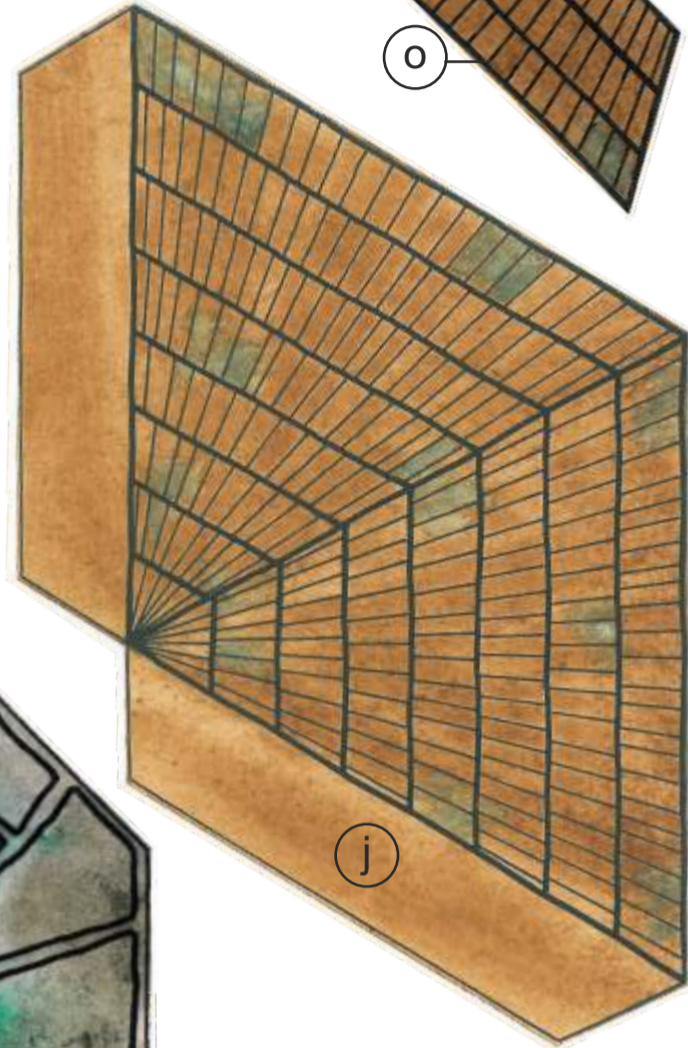

WALACHIA®

